

Canopy Assembly Manual

Designed by Larry vs Harry

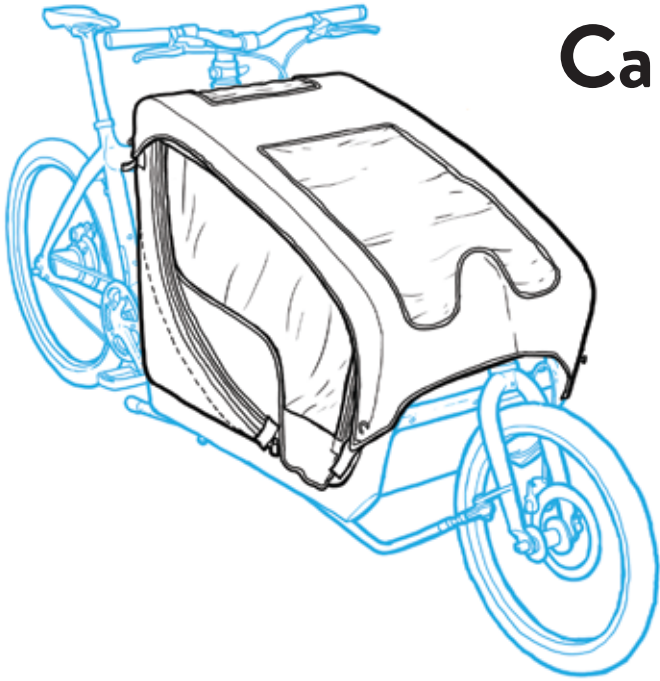

For further information, check out the website : www.larryvsHarry.com or your local dealer.

Before you start

Things you need to attach your brandnew canopy :

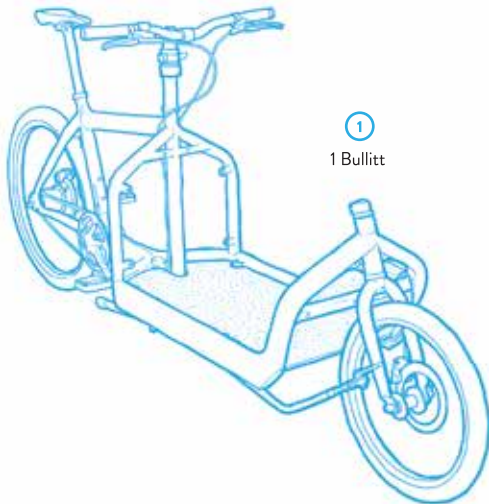

2

13 MM
Wrench/Spanner



3

5 MM
Hex/Allen key



4

Grease for sensitive parts
(metal on metal)



If you have bought the Bullitt Childseat and want to attach it inside the canopy, you remove the bolts and attach the child seat to the back holes instead.



Icons that will appear through out the guide



Ouch! Be careful, you could hurt your fingers.



Grease. Remember to grease or else your mechanic will hate you later on.



Important message from Larry the King.

Components

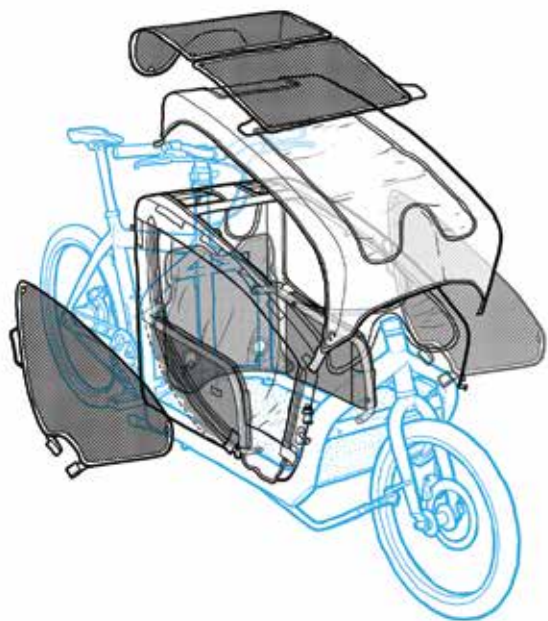

1: Canopy cover



2: Sidebars

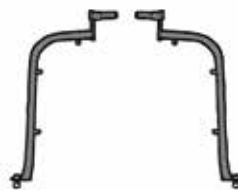

3: Top sun screens



4: Roof



5: Back protection



6: Side sun screens



Step1

Two tips before you start attaching the Canopy:

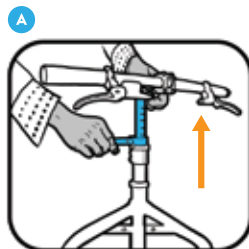
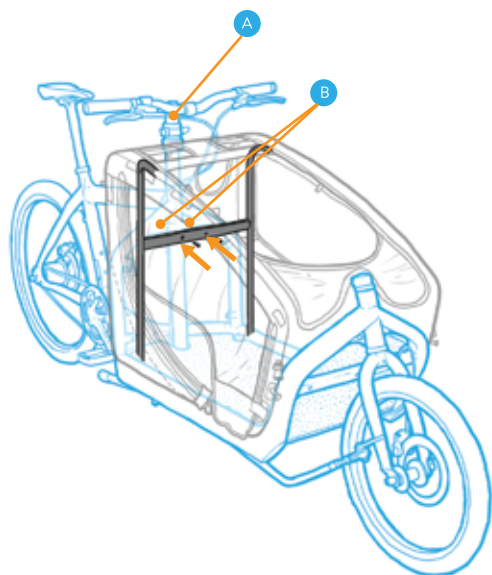

Raise your handlebar to the max to make room for the canopy.

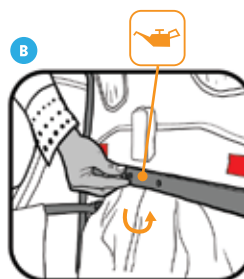

Before attaching the canopy frame remove the two bolts inside the Canopy. Use tools 1+2.

The bolts fits the Canopy onto the actual bicycle frame. Fit them when you finish **Step2**.

King Larry says:
"If you have bought the Bullitt Childseat and want to attach it inside the Canopy you remove the bolts and attach the child seat to the back holes instead"



Step2

Fitting the canopy the onto the frame:

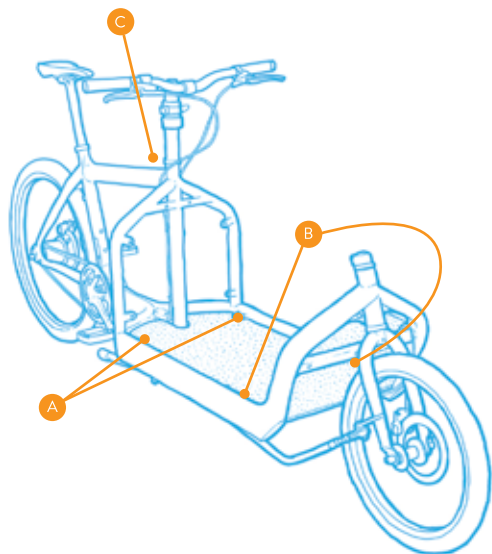

1

Steering this way



Unfold the cover, remove all strips and place it on the bike. Backside of the cover facing the steerer assembly.

2

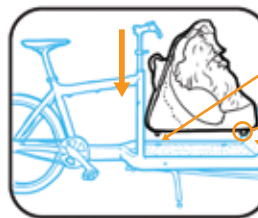

Like this.

Fit the hook (A) on the front of the canopy onto the frame and the pin (B) into the back hole on the bottom of the frame.

3



Drag the cover backwards towards the steerer assembly.

4

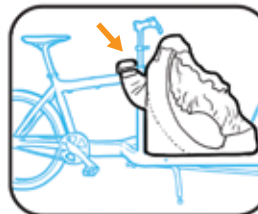

Attach the velcro on the bicycle frame.

Step3

Assembling the roof bars:

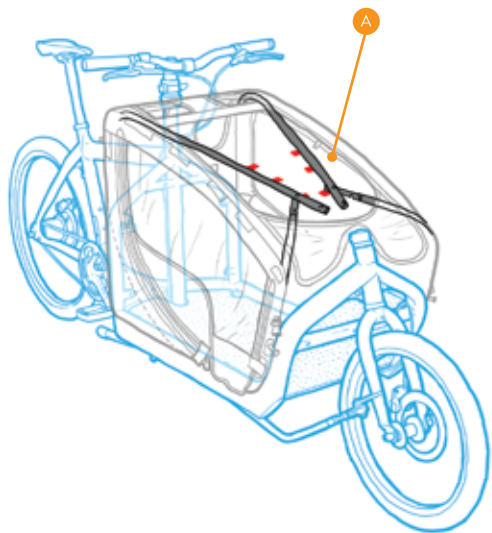

1

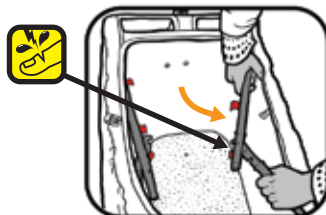

Bend the bars on the roof of the canopy into position. Be careful - you could cut your fingers!

2

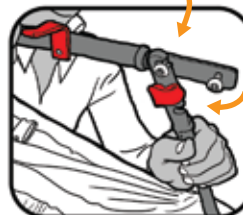

Bottom view.

3

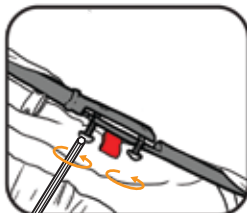

Tighten the screws with hex/aluminum key tool and repeat step 3 on the opposite side of the canopy.

Step4

Assembling the side bars:

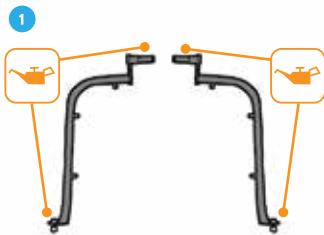
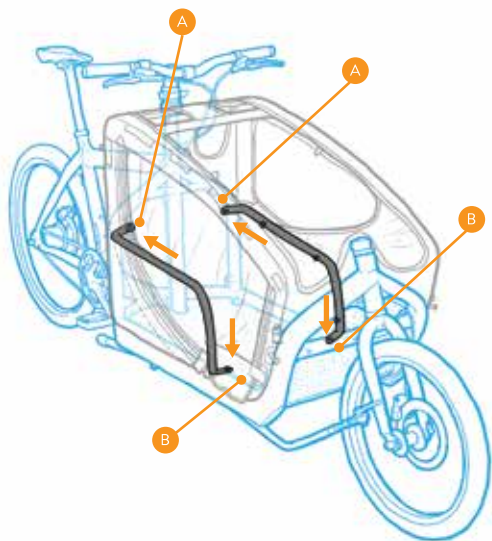

Get your Sidebars. Unscrew the bolts. Notice that the bolts are slightly different. A one goes in hole D on the frame.



Like this...



...not like this.

King Larry says :
"Fit the sidebars right
or your ass will have
to be tight"
"urghurgh!"



Step5

Attaching the cover to the side bars:

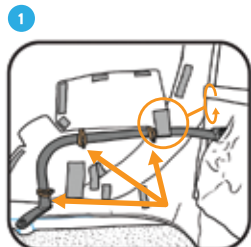
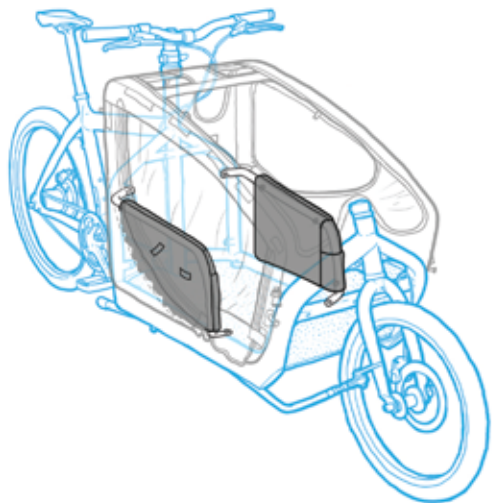

Attach the rubbers to the straps. Attach the velcro round the bar.



Put the velcro strap through the hole.

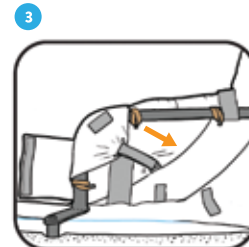

And attach it like dissss!

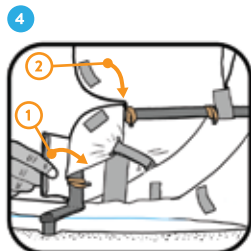

Attach the flaps in the following order.

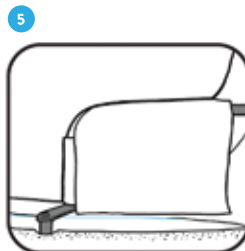

Viola! Finished!

Step6

Attach the cover to the roof bars:

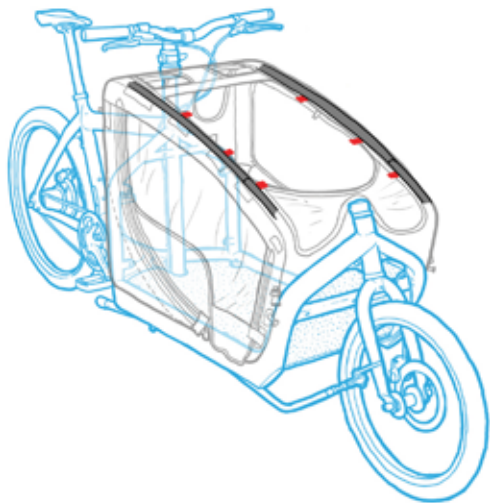

Zip the sides of the windows and attach the velcro so its nice and tight. Do it on both sides of the canopy.

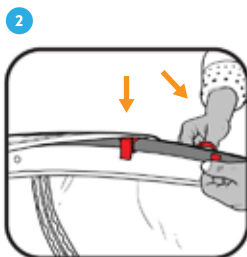

Put the velcro straps through the hole and attach it. Repeat on the opposite side.

Important notice from The King Larry.
When you get to this stage, the best thing is to leave the Canopy to rest for 24 hrs. It's so the fabric can stretch. If not patient...

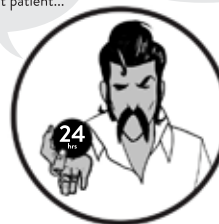

This could happen!
Broken side window or zipper could be the consequence...



We make the only side entrance Canopy in the universe and it has a prize. The prize is patience.

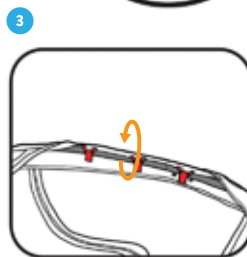

Bend the cover back and you are good to go.

Step7

Mounting the back protection:

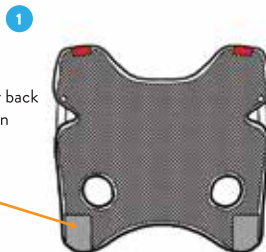
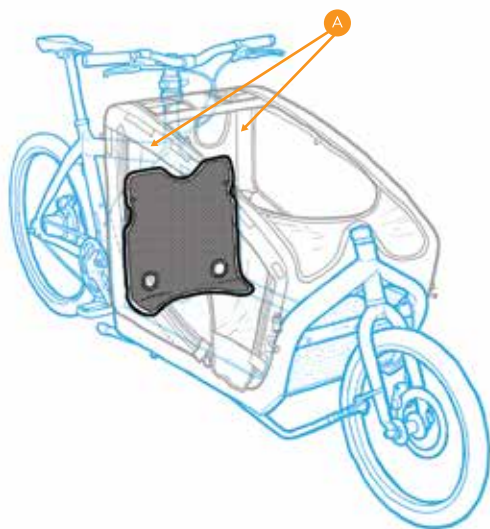

Get your back projection

Match the the red velcro to the inside backof the canopy cover.

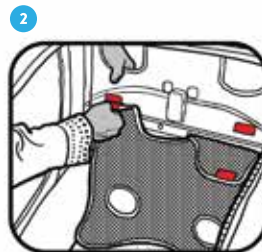

Attach the velcro.

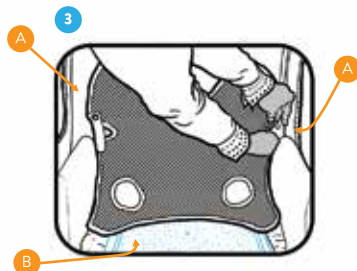

Step8

Fitting the sun screen to the side:

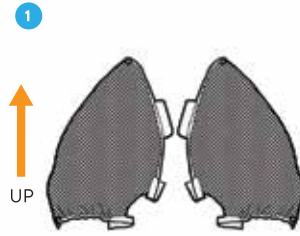
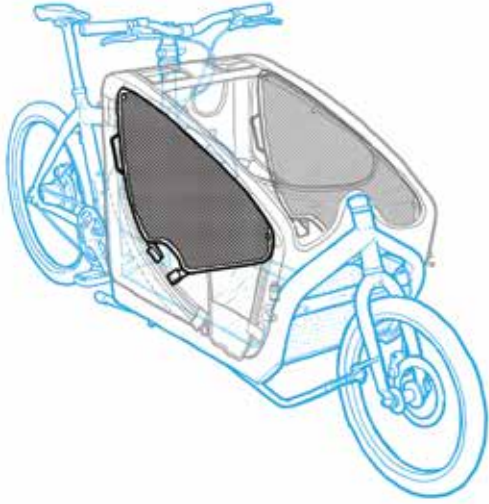

1 Get your sun screen.

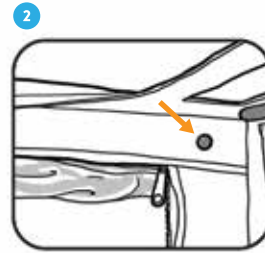

2 On the inside top back corner is a button. Find it and match it with the button on the sun screen.

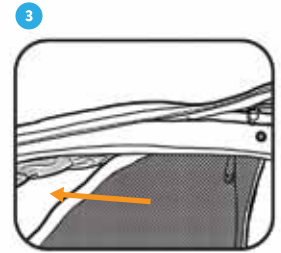

3 Attach the velcro on the Sun screen onto the inside of the flap all the way to the front of the "window". Finish by clicking the button at the front on to the canopy inside.



4 Attach the velcro hinges on the Sun screen onto the outside of the canopy.

Step9

Attaching the roof:

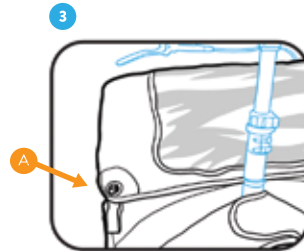
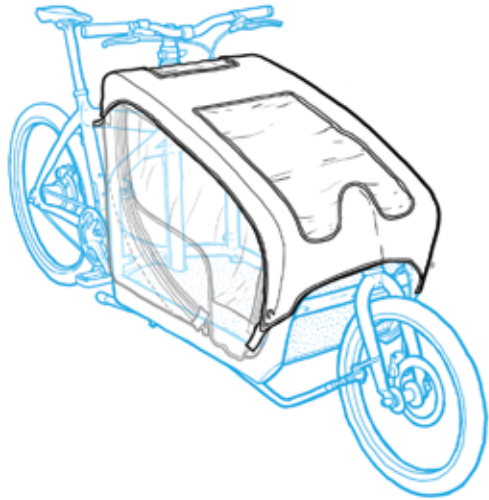

1 Get your roof and Fit the holes (A) on to the back of the canopy on both sides.



2 Roll it forward.



3 Attach the two buttons on the inside roof to the two sun screens.



4 Stretch it forward and attach the holes on each side on to the taps of the front canopy.

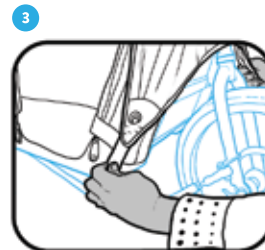

5 And attach the velcro at the end to the canopy.



6 Finito!

Step Xtra

*to use the sunscreens, you need to also attach the roof. You can, however, use the roof without the sun screens.

